



F6908

LINEAR INTEGRATED CIRCUIT

SINGLE-PHASE FULL-WAVE MOTOR DRIVER FOR FAN MOTOR

DESCRIPTION

UTC **F6908** is a single-phase full-wave motor driver for fan motor suitable for 5V and 12V operations.

FEATURES

- * Soft Switching Drive for Low Noise
- * Lock Detection and Automatic Restart Function
- * Thermal Shut-Down Protection

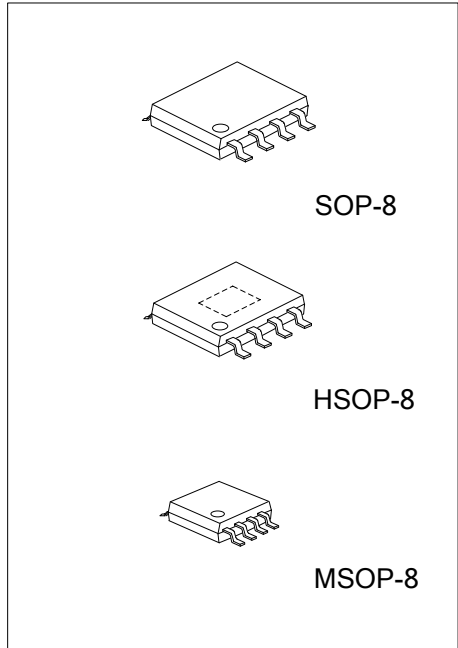

ORDERING INFORMATION

Ordering Number	Package	Packing
F6908G-S08-R	SOP-8	Tape Reel
F6908G-SH2-R	HSOP-8	Tape Reel
F6908G-SM1-R	MSOP-8	Tape Reel

<p>F6908G-S08-R</p> <p>(1) Packing Type</p> <p>(2) Package Type</p> <p>(3) Green Package</p>	<p>(1) R: Tape Reel</p> <p>(2) S08: SOP-8, SH2: HSOP-8, SM1: MSOP-8</p> <p>(3) L: Lead Free, G: Halogen Free and Lead Free</p>
--	--

MARKING

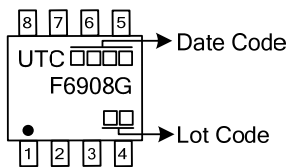

■ PIN CONFIGURATION

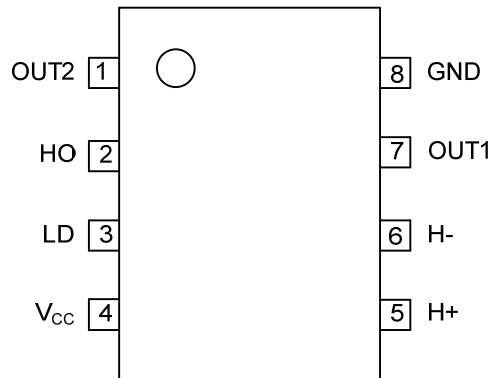

■ PIN DESCRIPTION

PIN NO	PIN NAME	FUNCTION
1	OUT2	Output 2
2	HO	Hall signal output pin
3	LD	Capacitor terminal for Lock detection, Auto restart
4	V _{CC}	Power supply pin
5	H+	Hall signal input pin +
6	H-	Hall signal input pin -
7	OUT1	Output 1
8	GND	GROUND

■ BLOCK DIAGRAM

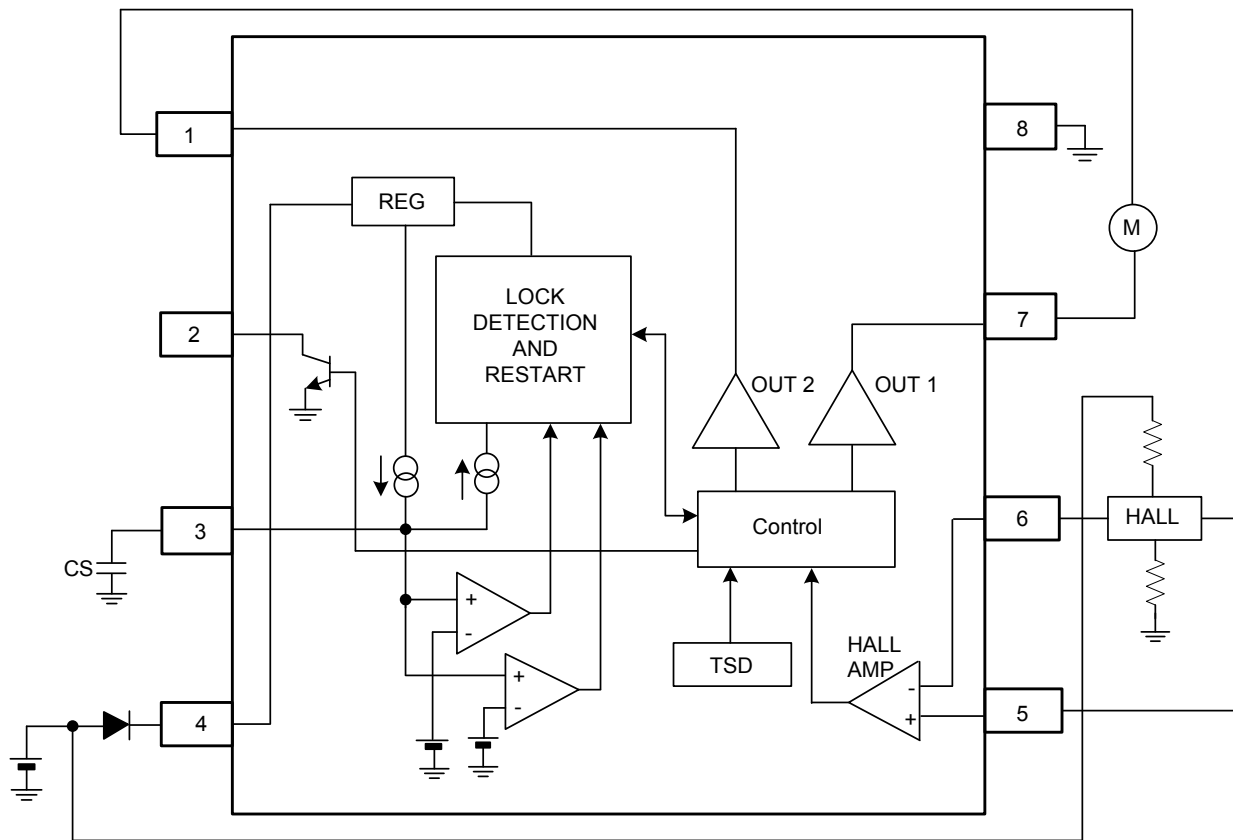

■ HALL SIGNAL INPUT-OUTPUT TRUTH TABLE

H+	H-	OUT1	OUT2	HO
H	L	H	L	H
L	H	L	H	L

Condition: LD=0V

■ ABSOLUTE MAXIMUM RATINGS ($T_A=25^{\circ}\text{C}$, unless otherwise specified)

PARAMETER		SYMBOL	RATINGS	UNIT
Supply Voltage		V_{CC}	15	V
Output Voltage		V_{OUT}	15	V
Hall Signal Output Voltage		V_{HO}	15	V
Output Current		I_{OUT}	0.7(Note 2)	A
Hall Signal Output Current		I_{HO}	15	mA
Power Dissipation	SOP-8/HSOP-8	P_D	687 (Note 3)	mW
	MSOP-8		390	
Junction Temperature		T_J	+150	$^{\circ}\text{C}$
Operating Temperature		T_{OPR}	-20 ~ +100	$^{\circ}\text{C}$
Storage Temperature		T_{STG}	-40 ~ +150	$^{\circ}\text{C}$

Notes: 1. Absolute maximum ratings are those values beyond which the device could be permanently damaged.

Absolute maximum ratings are stress ratings only and functional device operation is not implied.

2. This value is not to be over P_D and ASO.

3. To use at temperature above $T_A = 25^{\circ}\text{C}$ reduce 5.5 mW/ $^{\circ}\text{C}$.

(On 70.0mm×70.0mm×1.6mm glass epoxy board)

■ RECOMMENDED OPERATING CONDITIONS ($T_A=25^{\circ}\text{C}$, unless otherwise specified)

PARAMETER	SYMBOL	RATINGS	UNIT
Supply Voltage	V_{CC}	3 ~ 14	V

■ ELECTRICAL CHARACTERISTICS ($T_A=25^{\circ}\text{C}$, $V_{CC}=5\text{V}$, unless otherwise specified)

PARAMETER	SYMBOL	TEST CONDITIONS	MIN	TYP	MAX	UNIT
Clamp Voltage of Capacitor for Lock Detection	V_{LDCL}		1.14	1.80	2.47	V
Reference Voltage of Capacitor for Lock Detection	V_{LDCLP}		0.47	0.76	1.06	V
Output Voltage L	V_{OL}	$I_{OUT}=200\text{mA}$		0.2	0.3	V
Output Voltage H	V_{OH}	$I_{OUT}=200\text{mA}$	3.9	4.1		V
"HO" Terminal Voltage L	V_{HOL}	$I_{HO}=5\text{mA}$		0.3	0.5	V
Supply Current	I_{CC}	At output: OFF	1.5	3.4	8.7	mA
Charge Current of Capacitor for Lock Detection	I_{LDC}	$V_{LD}=1.1\text{V}$	1.50	2.75	4.50	μA
Discharge Current of Capacitor for Lock Detection	I_{LDD}	$V_{LD}=1.1\text{V}$	0.24	0.48	0.90	μA
"HO" Terminal Leak Current	I_{HOL}	$V_{HO}=15\text{V}$		0	50	μA
Charge-Discharge Current Ratio of Capacitor for Lock Detection	R_{CD}	$r_{CD}=I_{LDC}/I_{LDD}$	4.2	5.7	9.5	
Hall Input Offset Voltage	H_{OFS}		-10		10	mV
Hall Input-Output Gain	GHO		320	500	680	
Thermal Shutdown				150		$^{\circ}\text{C}$
TSD Hysteresis	TSD			25		$^{\circ}\text{C}$

■ POWER DERATING CURVE

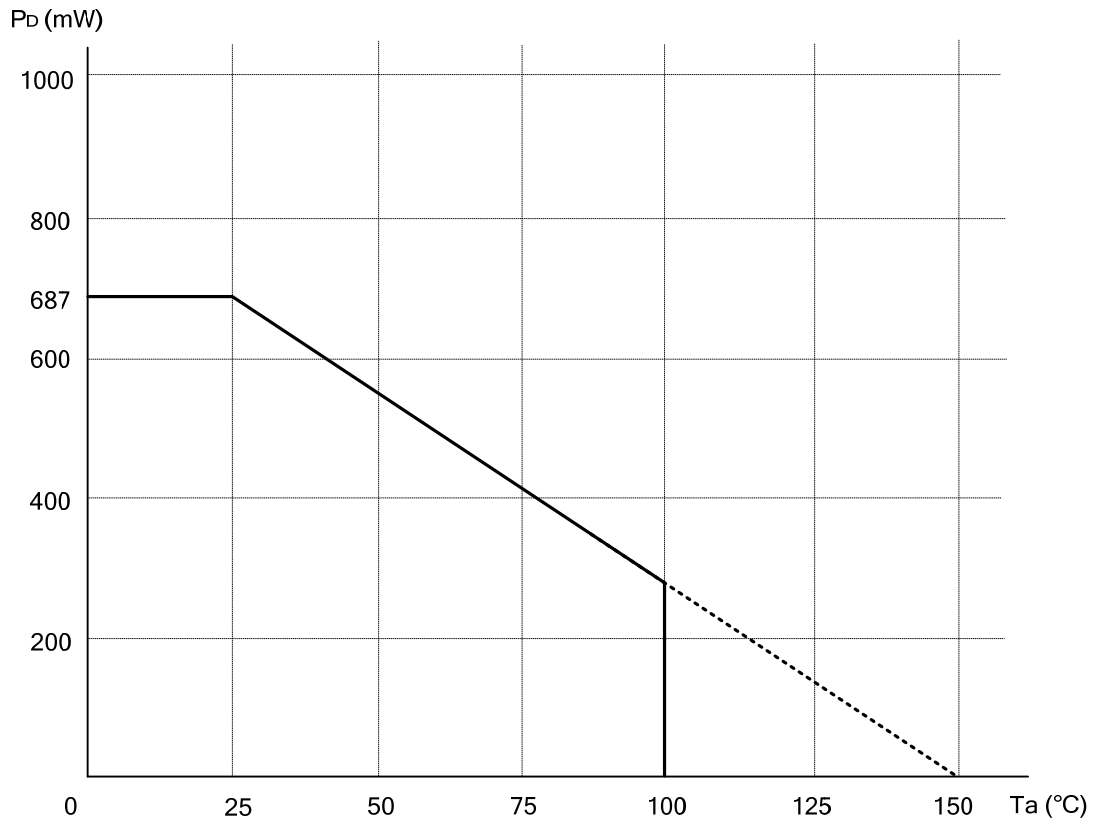

To use at temperature above Ta=25°C reduce 5.5mW/°C
(On 70.0mm×70.0mm×1.6mm glass epoxy board)

■ LOCK DETECT CIRCUIT, AUTOMATIC RESTART CIRCUIT

Charge and discharge time at motor lock condition varies with the value of external capacitor at LD terminal, and is given by the following equation.

$$T_{ON}(\text{Charge time}) = \frac{C \times (V_{LDCL} - V_{LDCLP})}{I_{LDC}}$$

$$T_{OFF}(\text{Discharge time}) = \frac{C \times (V_{LDCL} - V_{LDCLP})}{I_{LDD}}$$

C: Capacitor at LD pin

The following value shows charge time and discharge time at C=0.47μF for reference.

Charge time = 0.18S (Output: ON)

Discharge time = 1.02S (Output: OFF)

■ SHOWS TIMING CHART OF LD PIN

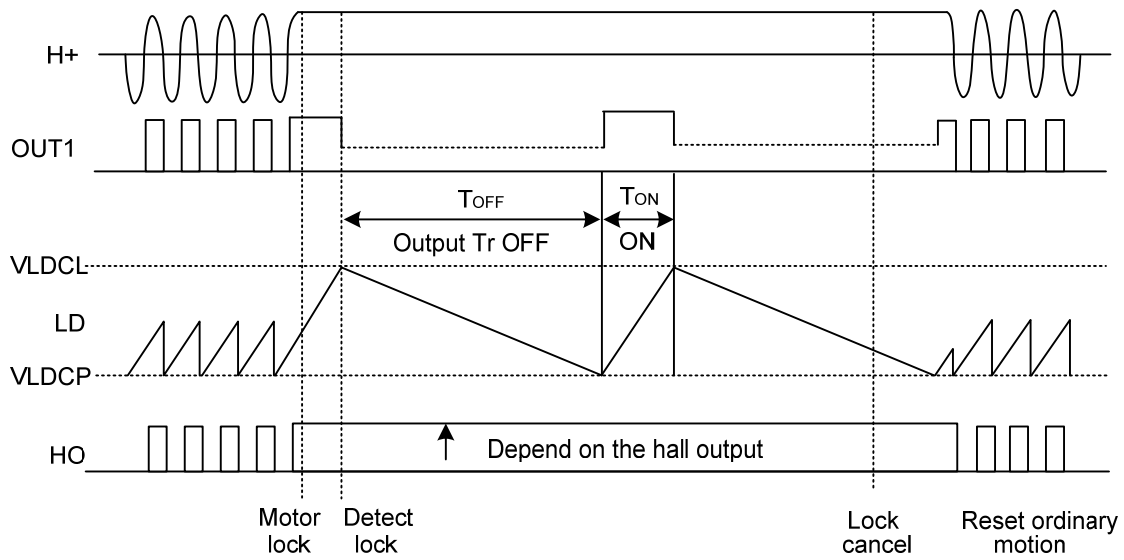

Fig.1 Timing chart (LD terminal, HO terminal)

■ CAUTIONS

(1) Power dissipation

IC power dissipation varies widely with supply voltage, output current and application of IC. Please pay attention not to exceed the allowable power rating.

(2) Hall signal input terminals (H+, H-)

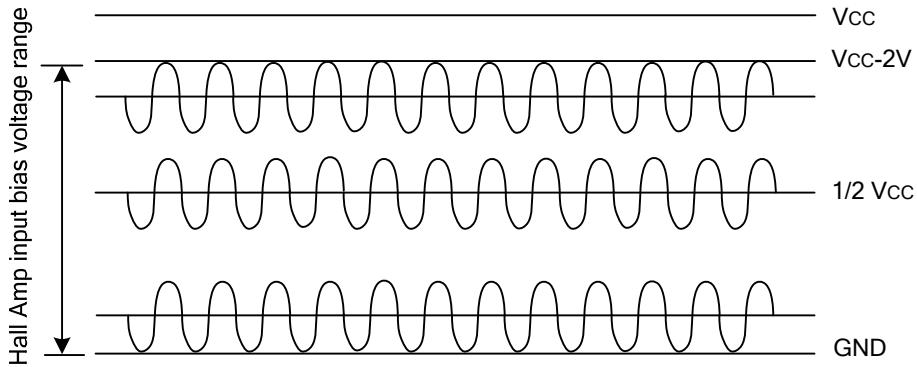

Fig.2 Hall amp input bias voltage range

A. Hall signal amplitude should be key within range 0V ~ $V_{CC}-2V$.

B. The output signal of this IC is the amplified by about 500 times of hall input signal coith pattern shown below for different level ok signal input.

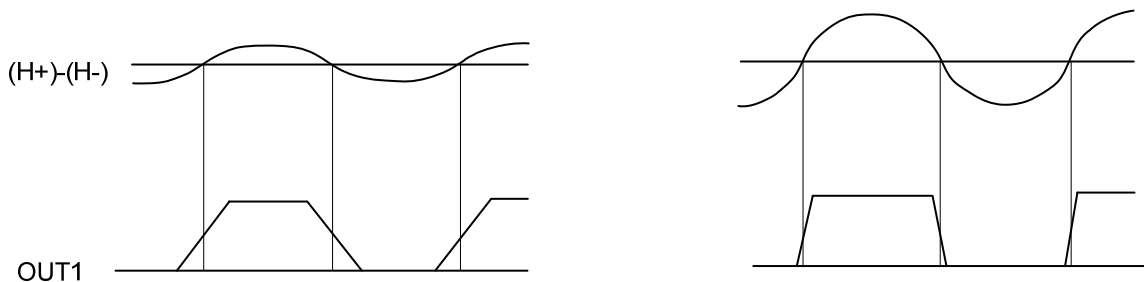

Fig.3 Difference of output signal depending on hall input signal

UTC assumes no responsibility for equipment failures that result from using products at values that exceed, even momentarily, rated values (such as maximum ratings, operating condition ranges, or other parameters) listed in products specifications of any and all UTC products described or contained herein. UTC products are not designed for use in life support appliances, devices or systems where malfunction of these products can be reasonably expected to result in personal injury. Reproduction in whole or in part is prohibited without the prior written consent of the copyright owner. The information presented in this document does not form part of any quotation or contract, is believed to be accurate and reliable and may be changed without notice.